

Wilsonart® Solid Surface Profile Shapes

2" - 3" Profile Options

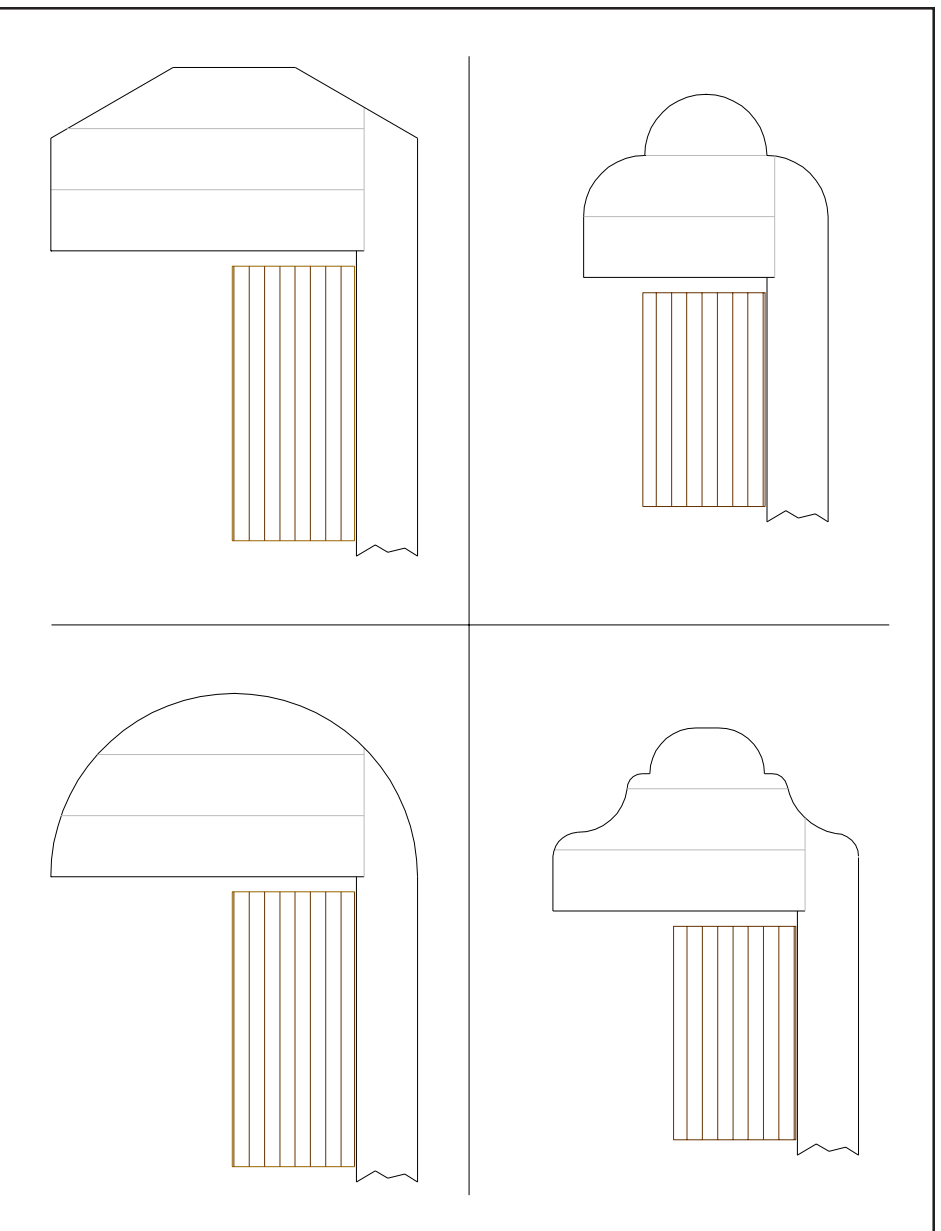

Router bit manufacturers contact information:

Fred Velepec Co. Inc..... (800) 365-6636

Amana Tool® (800) 445-0077

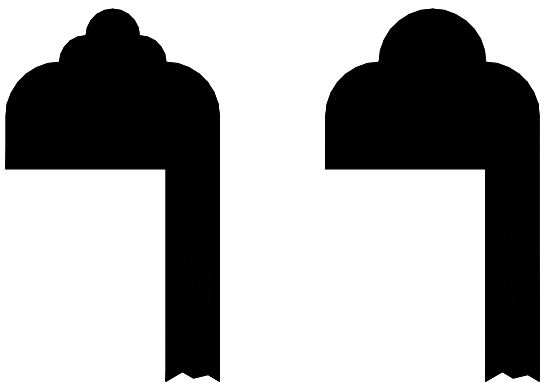

PG 4

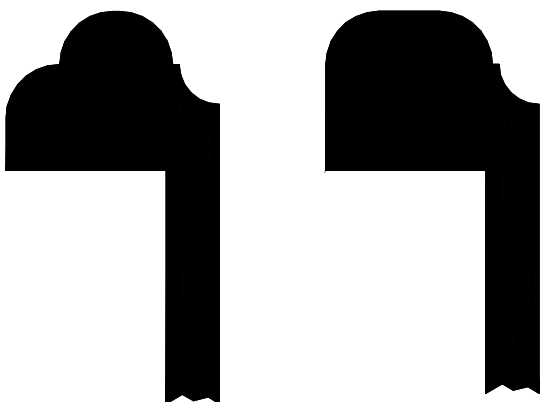

PG 5

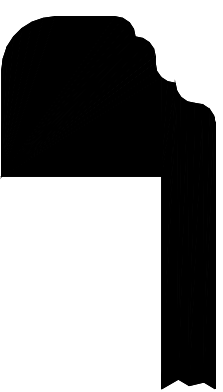

PG 6

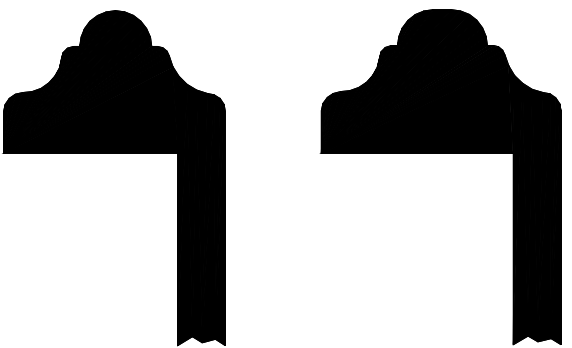

PG 7

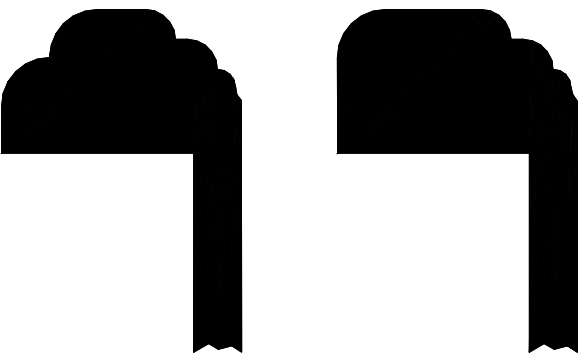

PG 8

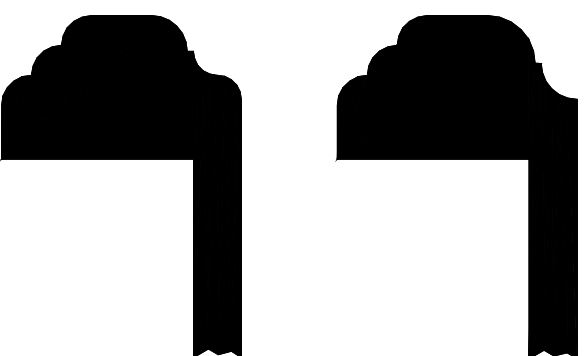

PG 9

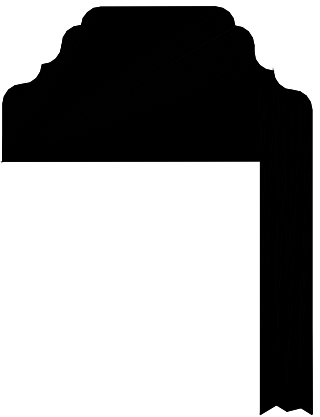

PG 10

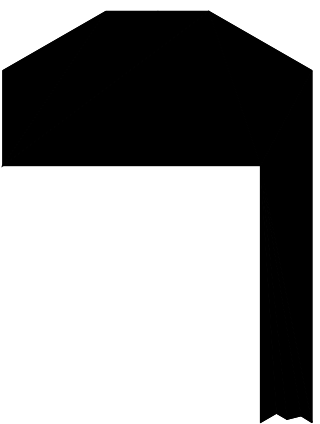

PG 11

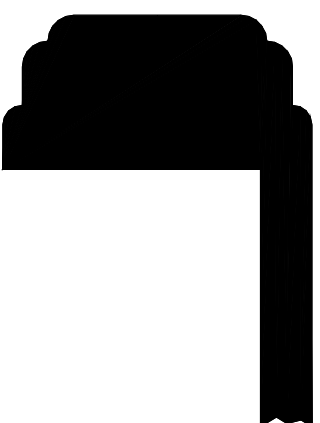

PG 12

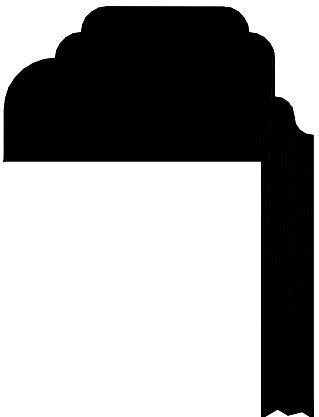

PG 13

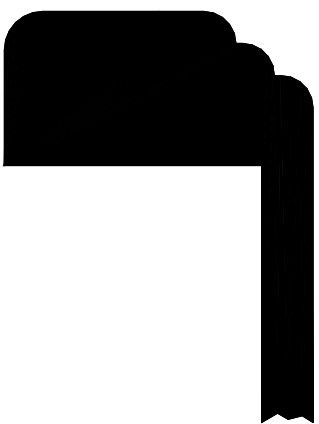

PG 14

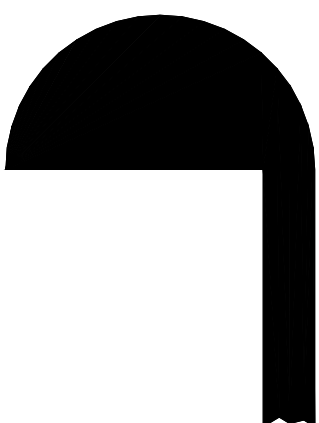

PG 15

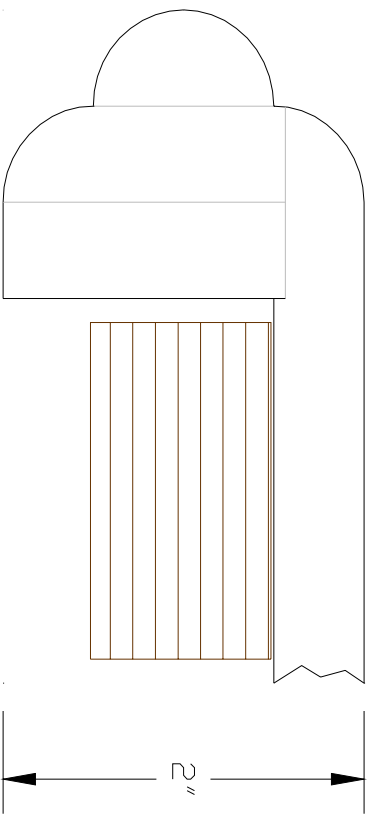

Hampton

- Manufacturer Router Bit Part #
- Velepec.....Hampton #108
- Amana.....57214

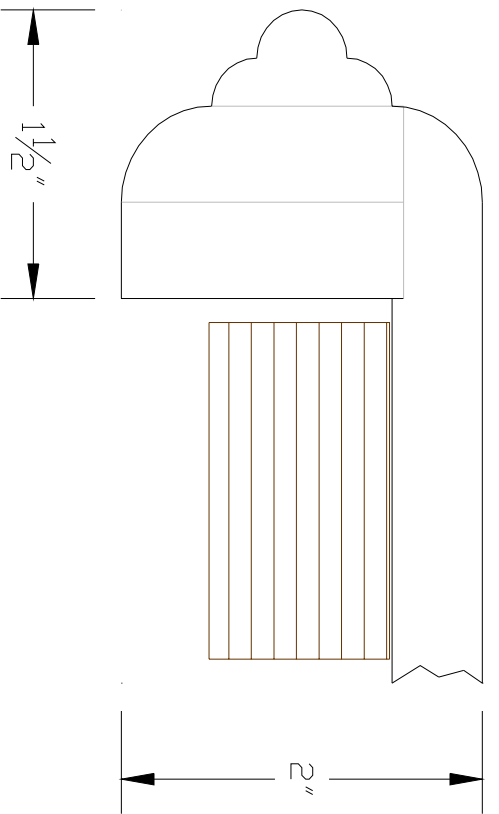

Hillside

- Manufacturer Router Bit Part #
- Velepec.....Hillside #103
- Amana.....57208

1. Note:
Dimensions listed may vary depending on desired edge
2. thickness and selected profile.
Contact your local Wilsonart representative or fabricator for detailed information.

 Wilsonart® Solid Surface		Copywrite ©Wilsonart International 2002	
Description: Gibraltar Solid Surface		Title: Edge Profile	
edge profile cross section			
Dwg. By:	Date Dwg:	Scale:	Dwg #
RWM	9-04-02	NTS	2" Edge Profile

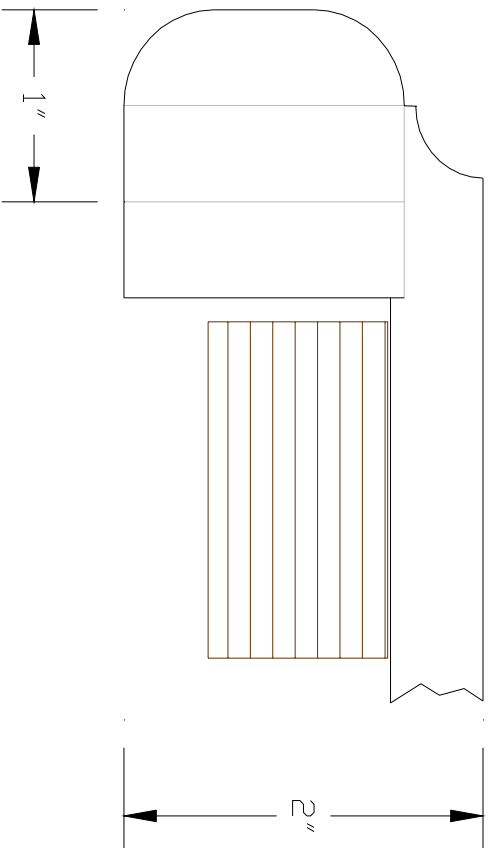

Manufacturer Router Bit Part #
 Velepec.....Montauk #107 (top)
 Amana.....57216 (top)
 Velepec.....22-370 (bottom)
 Amana.....57139 (bottom)

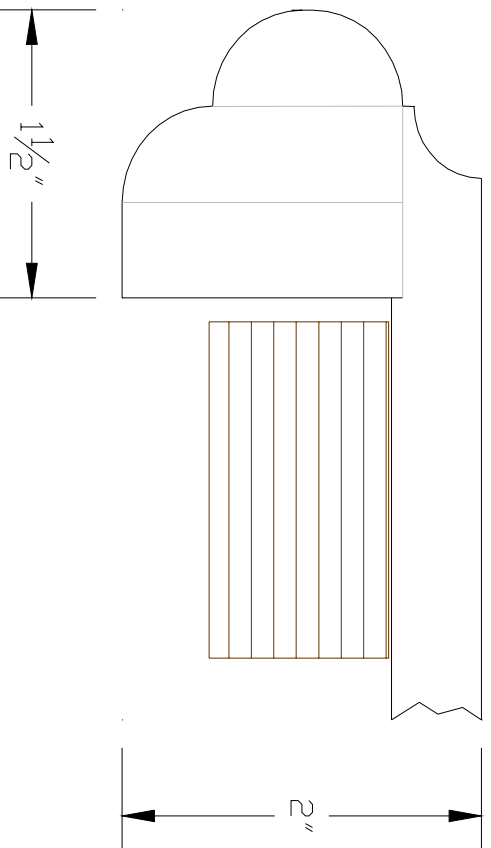

Manufacturer Router Bit Part #
 Velepec.....Montauk #107 (top)
 Amana.....57216 (top)
 Velepec.....Hampton #108 (bottom)
 Amana.....57214 (bottom)

Note:

1. Dimensions listed may vary depending on desired edge thickness and selected profile.
2. Contact your local Wilsonart representative or fabricator for detailed information.

Copywrite ©Wilsonart International 2002

 Wilsonart® Solid Surface		Title:	
Description: Gibraltar Solid Surface		Edge Profile	
edge profile cross section	Date Dwg:	Scale:	Dwg #
Dwg. By: RWM	9-04-02	NTS	2" Edge Options

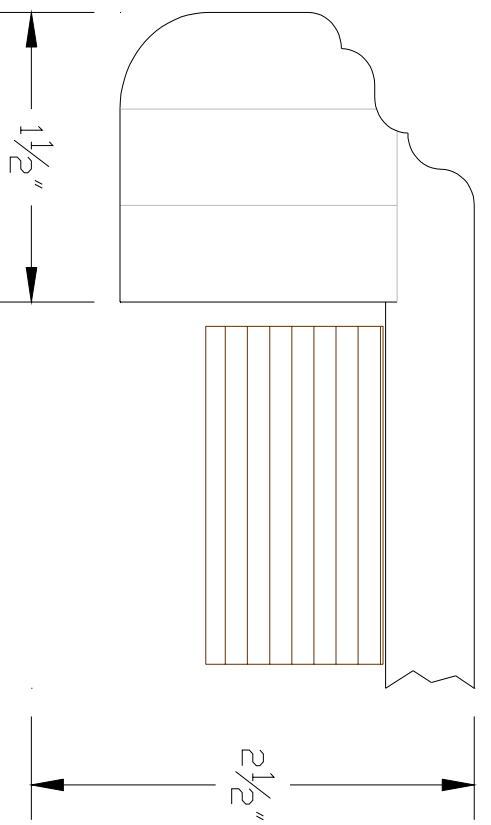

Barker

Manufacturer Router Bit Part #

Velepec.....Barker #107 (top)

Amana.....57212 (top)

Velepec.....22-370 (bottom)

Amana.....57138 (bottom)

Note:

1. Dimensions listed may vary depending on desired edge thickness and selected profile.
2. Contact your local Wilsonart representative or fabricator for detailed information.

 Wilsonart® Solid Surface		Title: Edge Profile	
Description: Gibraltar Solid Surface			
edge profile cross section			
Dwg. By:	Date Dwg.:	Scale:	Dwg #
RWM	9-04-02	NTS	2" Edge Options

Copywrite ©Wilsonart International 2002

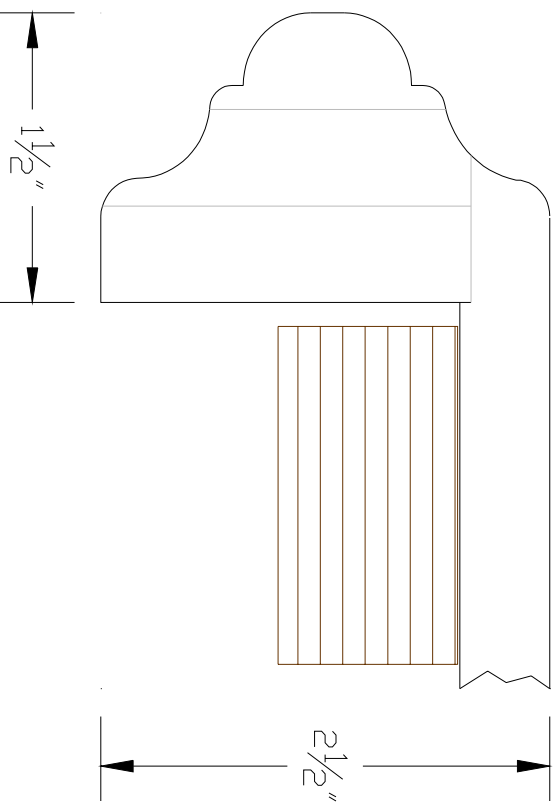
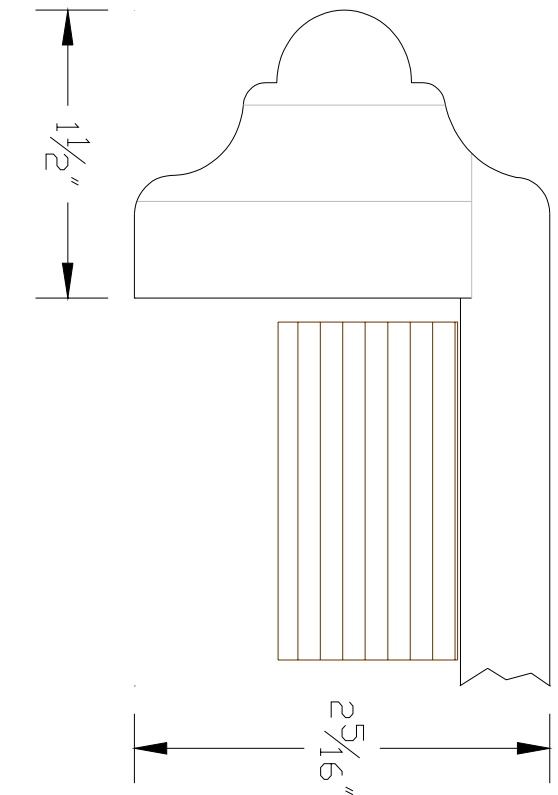

Bayside

Manufacturer Router Bit Part #

Velepec.....Bayside # 104

Amana.....57210

Note:

1. Dimensions listed may vary depending on desired edge thickness and selected profile.
2. Contact your local Wilsonart representative or fabricator for detailed information.

Copyright © Wilsonart International 2002

 Wilsonart® Solid Surface		Title:	
Description: Gibraltar Solid Surface		Edge Profile	
edge profile cross section			
Dwg. By:	Date Dwg:	Scale:	Dwg #
RWM	9-04-02	NTS	Bayside

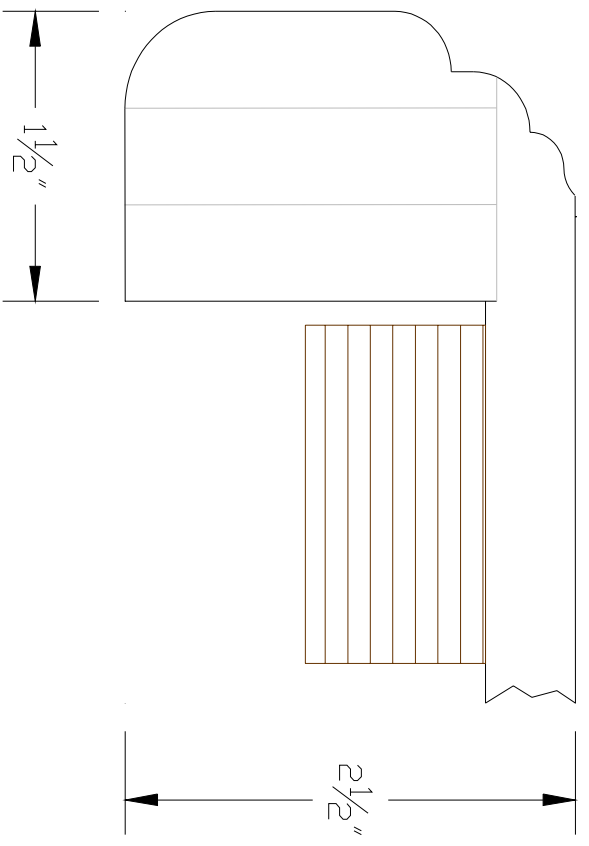
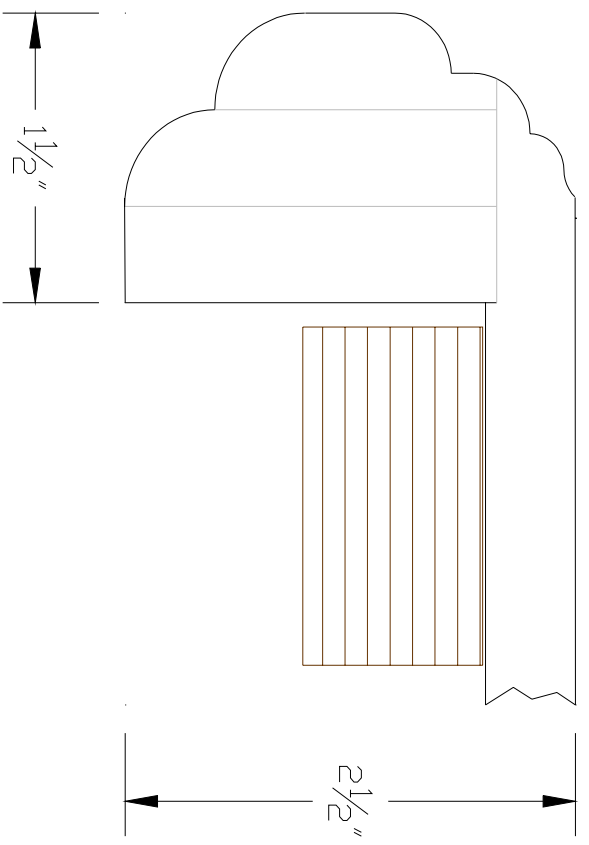

Manufacturer Router Bit Part #

Velepec.....Hunter #111

Amana.....57204

Manufacturer Router Bit Part #

Velepec.....Hunter #111 (top)

Amana.....57204 (top)

Velepec.....22-370 (bottom)

Amana.....57139 (bottom)

Note:

1. Dimensions listed may vary depending on desired edge thickness and selected profile.
2. Contact your local Wilsonart representative or fabricator for detailed information.

Copywrite © Wilsonart International 2002

 Wilsonart® Solid Surface Description: Gibraltar Solid Surface		Title: Edge Profile	
Dwg. By: RWM	Date Dwg: 9-04-02	Scale: NTS	Dwg # Hunter

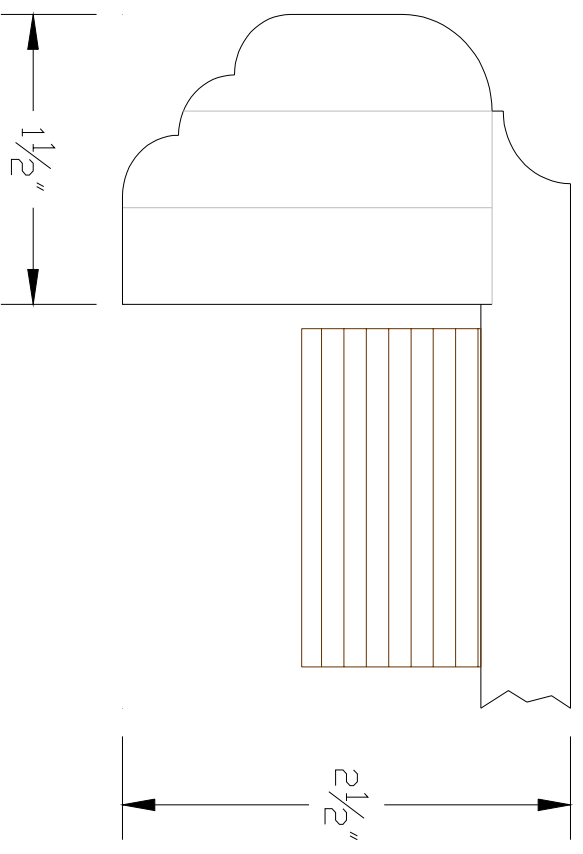
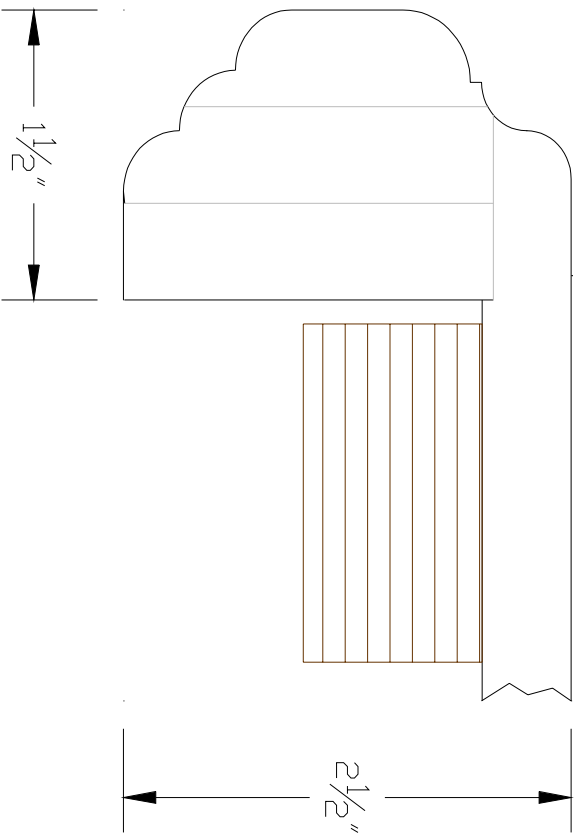

Manufacturer	Router Bit Part #
Velepec.....	Belmont #106 (top)
Amana.....	57218 (top)
Velepec.....	Hillcrest #109 (bottom)
Amana.....	56200 (bottom)

Manufacturer	Router Bit Part #
Velepec.....	Montauk #105 (top)
Amana.....	57216 (top)
Velepec.....	Hillcrest #109 (bottom)
Amana.....	56200 (bottom)

Note:

1. Dimensions listed may vary depending on desired edge thickness and selected profile.
2. Contact your local Wilsonart representative or fabricator for detailed information.

Copyright © Wilsonart International 2002

		Wilsonart® Solid Surface		Title:	
Description:		Gibraltar Solid Surface		Edge Profile	
edge profile cross section					
Dwg. By:	Date Dwg:	Scale:	Dwg #		
RWM	9-04-02	NTS	2 1/2" Edge Options		

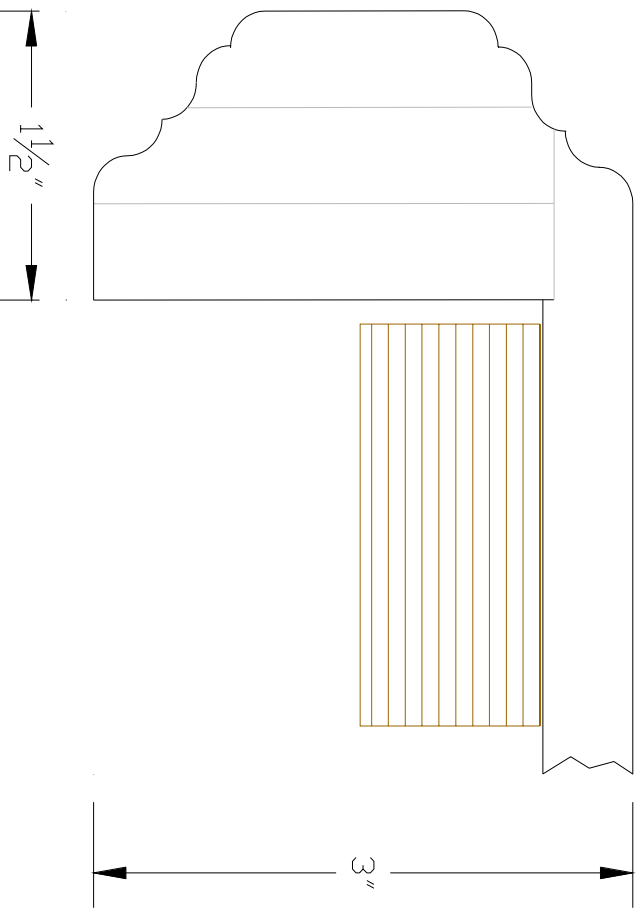

Manufacturer Router Bit Part #

Velepec.....Barker #107

Amana.....57212

Note:

Dimensions listed may vary depending on desired edge thickness and selected profile.

Contact your local Wilsonart representative or fabricator for detailed information.

Copyright © Wilsonart International 2002

 Wilsonart® Solid Surface		Title: Edge Profile	
Description: Gibraltar Solid Surface			
Dwg. By:	Date Dwg.:	Scale:	Dwg. #
RWM	9-04-02	NTS	Barker

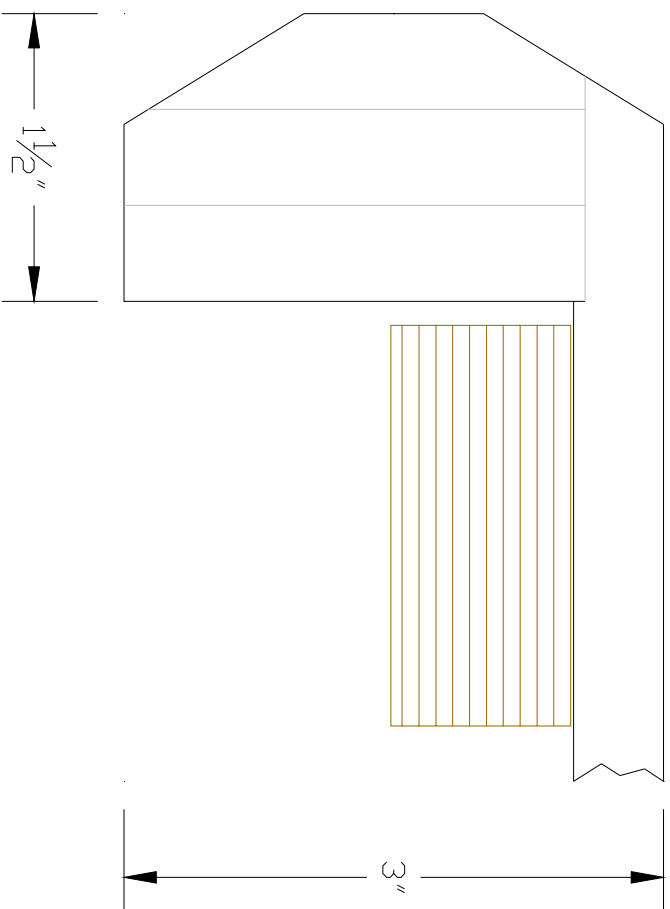

Manufacturer Router Bit Part #

Velepec.....Barker #107

Amana.....57212

Note:

Dimensions listed may vary depending on desired edge thickness and selected profile.

Contact your local Wilsonart representative or fabricator for detailed information.

 Wilsonart® Solid Surface		Title: Edge Profile	
Description: Gibraltar Solid Surface		Copyright © Wilsonart International 2002	
edge profile cross section			
Dwg. By:	Date Dwg.:	Scale:	Dwg #
RWM	9-04-02	NTS	Clifton

Manufacturer Router Bit Part #
 Velepec.....Hudson #112
 Amana.....57206

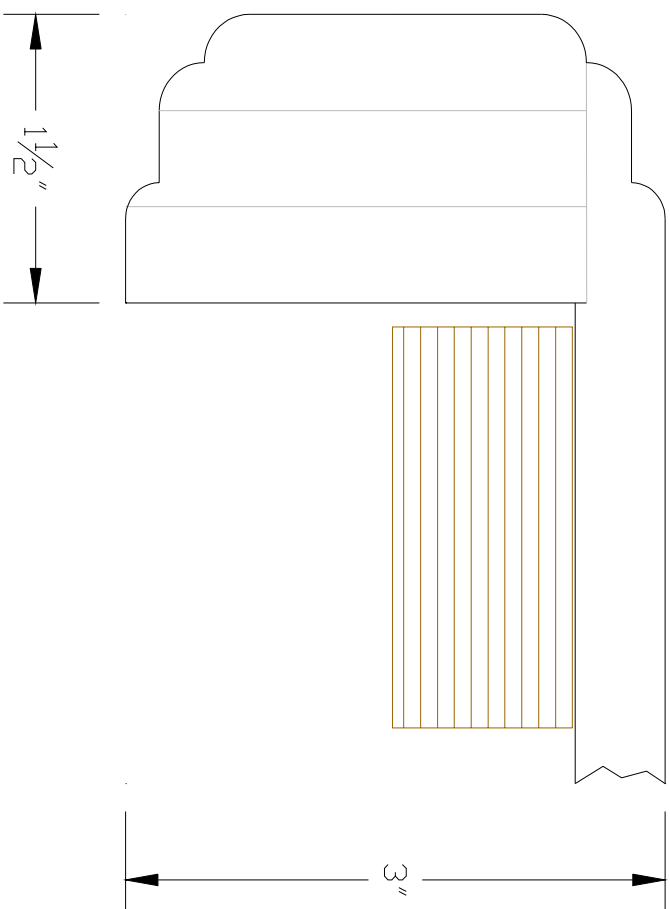

Note:
 Dimensions listed may vary depending on desired edge thickness and selected profile.
 Contact your local Wilsonart representative or fabricator for detailed information.

 Wilsonart® Solid Surface		Title: Edge Profile	
Description: Gibraltar Solid Surface			
edge profile cross section			
Dwg. By: RWM	Date Dwg: 9-04-02	Scale: NTS	Dwg # Hudson

Copyright © Wilsonart International 2002

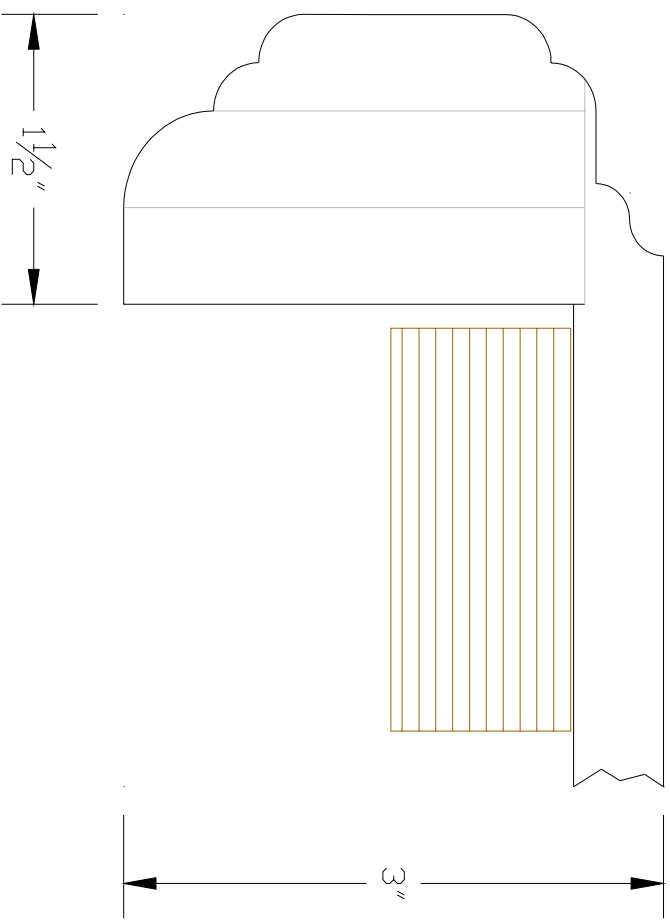

Manufacturer	Router Bit Part #
Velepec.....	Hudson #112 (top)
Amana.....	57206 (top)
Velepec.....	Hillside #109 (bottom)
Amana.....	56308 (bottom)

Note:
 Dimensions listed may vary depending on desired edge thickness and selected profile.
 Contact your local Wilsonart representative or fabricator for detailed information.

 Wilsonart® Solid Surface		Copyright © Wilsonart International 2002	
Description: Gibraltar Solid Surface		Title: Edge Profile	
edge profile cross section	Dwg. By: RWM	Date Dwg: 9-04-02	Dwg # Hudson - Hillside
Scale: NTS	Title: Hudson - Hillside		

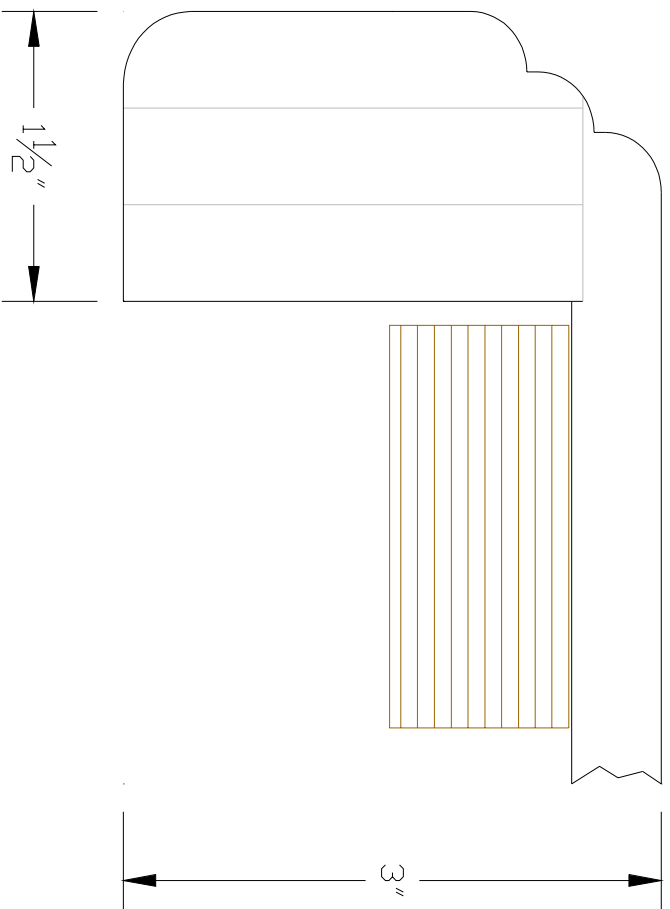

Manufacturer	Router Bit Part #
Velepec.....	Hillcrest #109 (top)
Amana.....	57200 (top)
Velepec.....	22-360 (bottom)
Amana.....	49514 (bottom)

Note:
 Dimensions listed may vary depending on desired edge thickness and selected profile.
 Contact your local Wilsonart representative or fabricator for detailed information.

 Wilsonart® Solid Surface		Copywrite © Wilsonart International 2002	
Description: Gibraltar Solid Surface		Edge Profile	
edge profile cross section Dwg. By: RWM	Date Dwg: 9-04-02	Scale: NTS	Dwg # Hillcrest

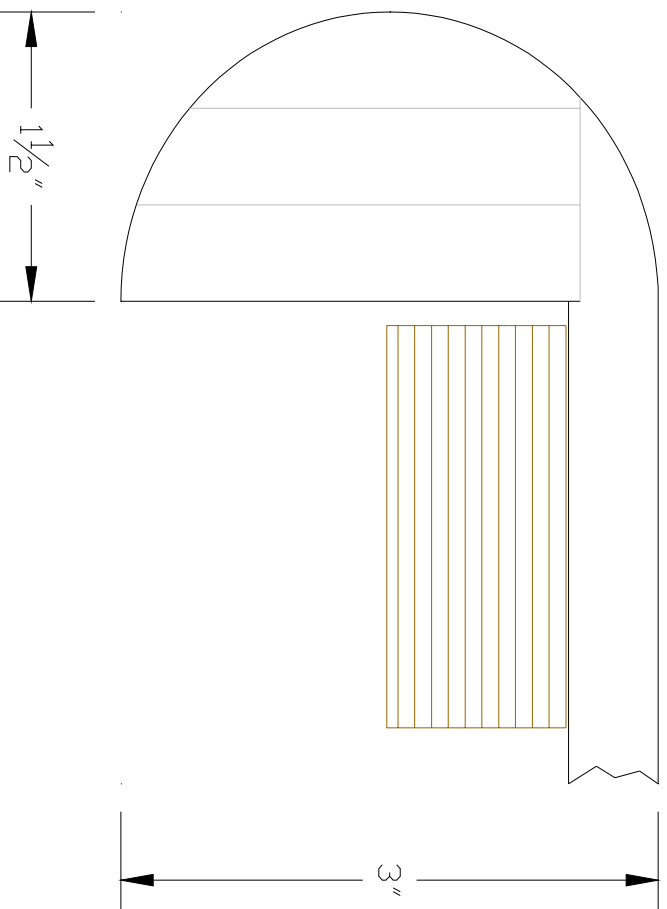

Manufacturer	Router Bit Part #
Velepec.....	30-380 (top)
Amana.....	57141 (top)
Velepec.....	22-300 (bottom)
Amana.....	57140 (bottom)

Note:

Dimensions listed may vary depending on desired edge thickness and selected profile.

Contact your local Wilsonart representative or fabricator for detailed information.

Copywrite ©Wilsonart International 2002

		Wilsonart® Solid Surface		Title:	
Description:		Gibraltar Solid Surface		Edge Profile	
edge profile cross section					
Dwg. By:	Date Dwg:	Scale:	Dwg #		
RWM	9-04-02	NTS	Bullnose		